

Quantum



goccia
ILLUMINAZIONE

Quantum

Quantum light body

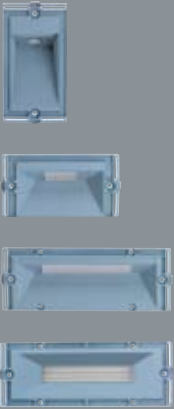

Quantum masks



Quantum post



Registered patent

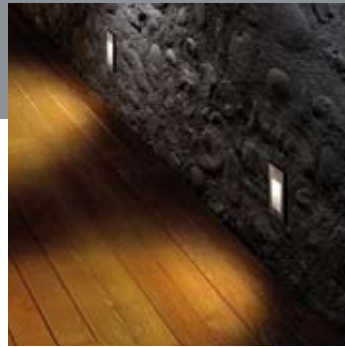
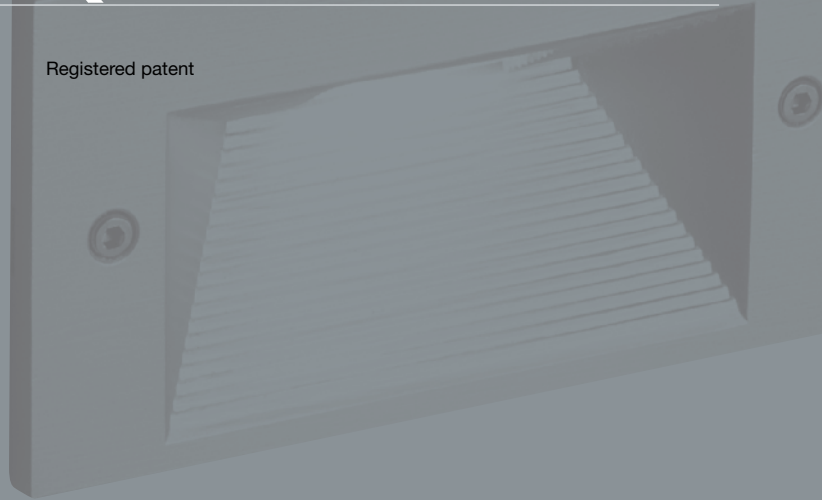

Quantum is a new range of recessed lighting fittings for outdoors planned to contain very efficient power leds. A new innovative concept offering significative options.

Small size: the light body, small and shallow, as result of a careful design of miniature shape, contains a well dimensioned thermic heat sink and the transformer 220-250 V / 12V. It allows to install Quantum in a normal and easy 220-250V power line. The back-boxes are small and shallow as well.

Maximum modularity: you can achieve the final look covering the light body with a wide range of masks in polycarbonate, aluminium different colors, or in matt finish stainless steel 316 L.

Different angle beam available: the light body shapes offer many types of lighting distributions and permit to choose the best light for your environment.

Power led performance: this range utilizes very efficient leds, especially dedicated to the habitat areas: very good color rendering index (85), 3,2 and 4,2 W for 320 lumen, and 50.000 h life.

Small and elegant garden posts complete the range. A first light is directed towards down to give light on the walkway plane and an second optional light in the opposite side can enlarge the lighting area in the other side of the post.



goccia
ILLUMINAZIONE



Quantum. New recessed lighting technology.

Easy and practical to install: the light body can be dressed by different types of Masks.

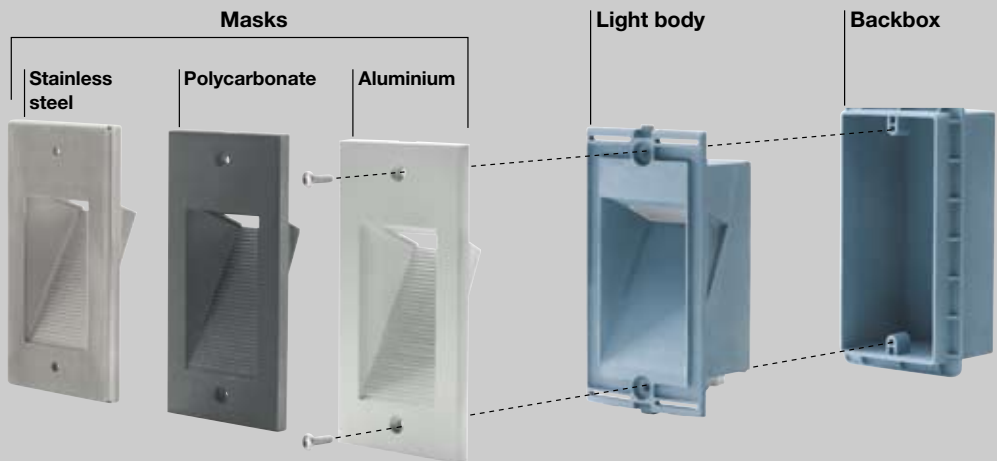

Five light bodies, three for the short backboxes and two for the long ones, contain the transformer and **can be connected to the 230V power line** (or 12V on request). Complete the lighting fitting and dress the body with Masks in the material you'll think right: the precious stainless steel 316 L, the aluminium in three different colors or the cheap polycarbonate.

The right light.

The inclined light shapes are made to push the light towards the ground: not to lose any lumen and to avoid any dazzling. The vertical versions distribute forward the light, the horizontal versions enlarge the angle beam and allow to increase the spacing between two lamps.

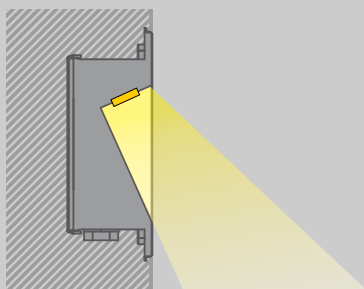

Power led efficiency.

Last generation power led. Be sure the light will be enough.

Watt	Lumen	Tonality	CRI - Color rendering index
1	60	3500°K	65
3,2	230	3500°K	85
4,2	320	3500°K	85

Small sizes: a great asset.

Inside a powerful heat sink keeps the temperature in the correct limit and the 220V-250V / 12V transformer allows to use a normal power line. 49 mm only inside in the wall.

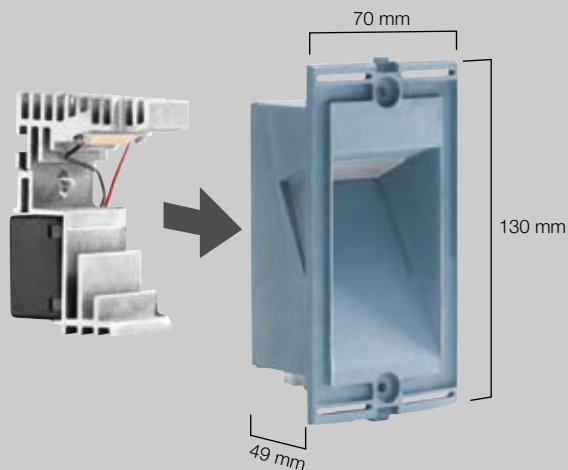



Maximum modularity: a good match for the right choice.

Light bodies	Masks						Materials
							
 1 W	■						Polycarbonate
	■						Aluminium
	■						Stainless steel
 3,2 W	■						Polycarbonate
	■						Aluminium
	■						Stainless steel
 3,2 W		■					Polycarbonate
		■					Aluminium
		■					Stainless steel
 4,2 W			■				Polycarbonate
			■				Aluminium
			■				Stainless steel
 4,2 W				■			Polycarbonate
				■	■	■	Aluminium
				■	■	■	Stainless steel

The garden post. Elegant and flexible.

The range Quantum is complete with a small and elegant garden post in aluminium or matt stainless steel 316 L. Thanks to the body 5421 or 5425 the basic light is downwards to illuminate on your walkway, but on the opposite side is possible an optional second light directed forward.

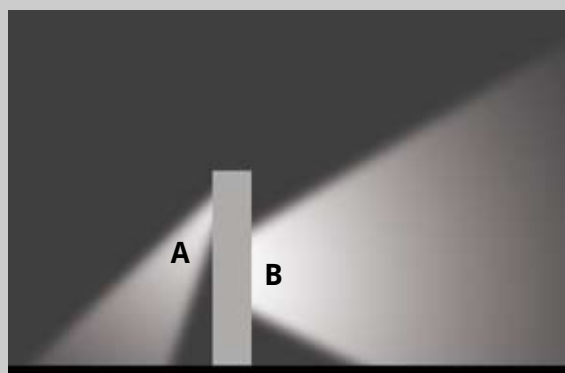



- Body in polycarbonate
- Stainless steel screws
- To be installed on the backbox cod. 5481
- Led 1 W incorporated
- 60 lumen
- Warm tonality 3.500 °K. / CRI color rendering index 65
- Life: 70% guaranteed after 50.000 h / progressive reduction until a max of 100.000 h
- 220-250V power / 350 mA - 12V incorporated
- IP65 Class II double insulation
- This series conforms to EN 60 598-1:04

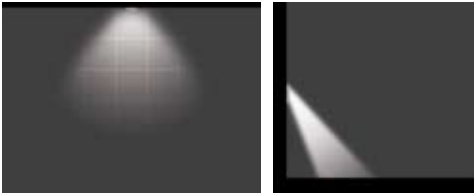
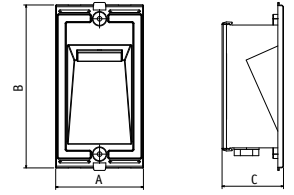

NEW

CODE NO.	Led	Watt	Lumen	A	B	C
5421		1	60	70	130	49

12V version on request.



- Body in polycarbonate
- Stainless steel screws
- To be installed on the backbox cod. 5481
- Led Citizen 3,2 W incorporated
- 230 lumen totally
- Warm tonality 3.500 °K. / CRI color rendering index 85
- Life: 70% guaranteed after 50.000 h / progressive reduction until a max of 100.000 h
- 220-250V power / 350 mA - 12V incorporated
- IP65 Class II double insulation
- This series conforms to EN 60 598-1:04

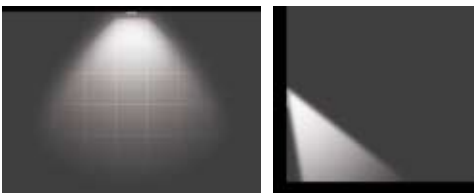
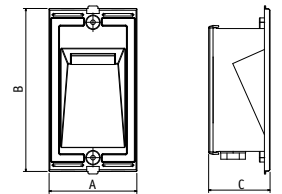

NEW

CODE NO.	Led	Watt	Lumen	A	B	C
5425		3,2	230	70	130	49

12V version on request.



- Id. code 5425

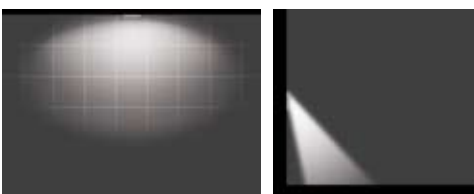
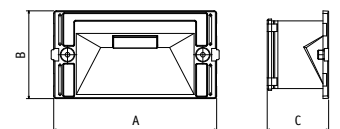

NEW

CODE NO.	Led	Watt	Lumen	A	B	C
5430		3,2	230	130	70	49

12V version on request.



- Body in polycarbonate
- Stainless steel screws
- To be installed on the backbox cod. 5482
- 58 Led Citizen 4,2 W incorporated
- 320 lumen totally
- Warm tonality 3.500 °K. / CRI color rendering index 85
- Life: 70% guaranteed after 50.000 h / progressive reduction until a max of 100.000 h
- 220-250V power / 350 mA - 12V incorporated
- IP65 Class II double insulation
- This series conforms to EN 60 598-1:04

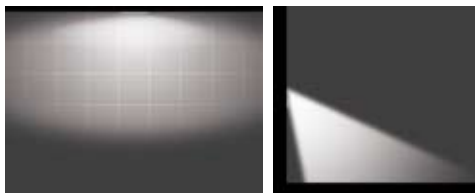
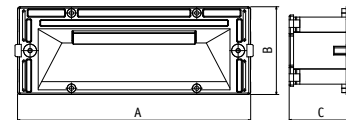

NEW

CODE NO.	Led	Watt	Lumen	A	B	C
5435		4,2	320	186	70	50

12V version on request.



- Id. code 5435

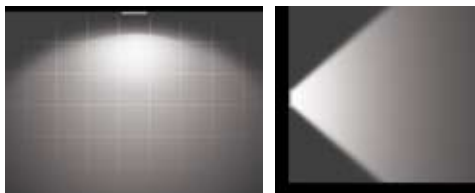
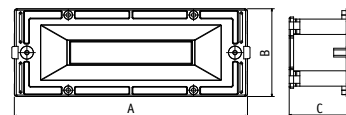

NEW

CODE NO.	Led	Watt	Lumen	A	B	C
5440		4,2	320	186	70	50

12V version on request.

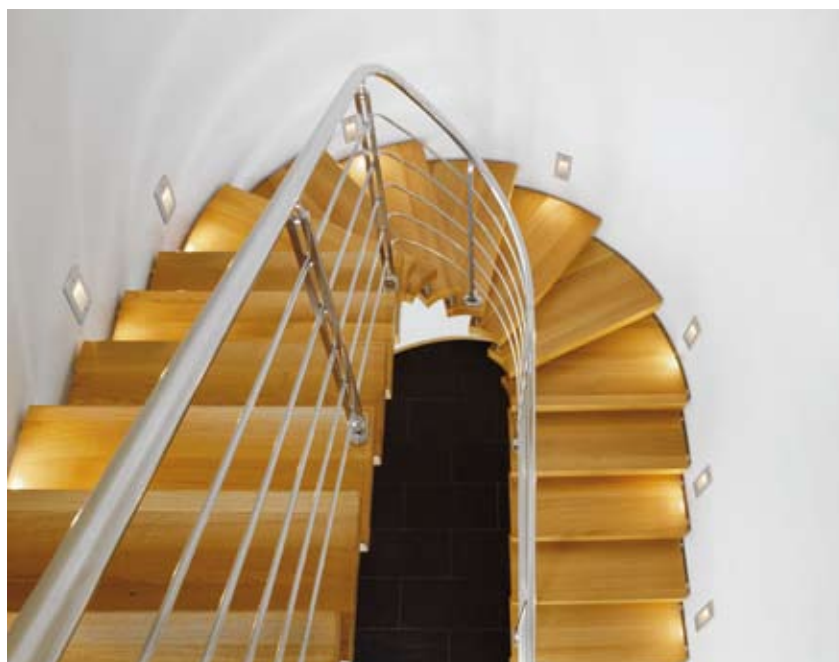



- Covering masks in polycarbonate
- Snap fastener + security screws

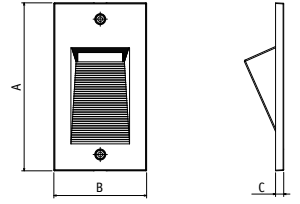

Colours **GR**

NEW

CODE NO.	Description	A	B	C
5452 *	Mask for 5421 and 5425	134	74	6,5

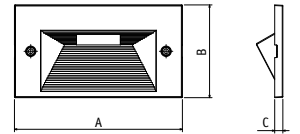

NEW

CODE NO.	Description	A	B	C
5453 *	Mask for 5430	134	74	6,5

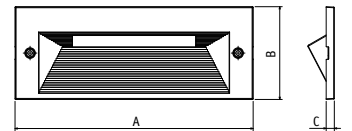

NEW

CODE NO.	Description	A	B	C
5454 *	Mask for 5435	190	74	6,5

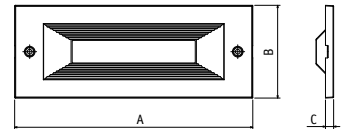

NEW

CODE NO.	Description	A	B	C
5455 *	Mask for 5440	190	74	6,5

- Covering masks in die-cast aluminium
- Snap fastener + security screws
- Pre-phosphochromed UV resistant painting

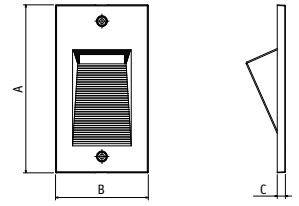

Colours **GR** **GM** **BI**

NEW

CODE NO.	Description	A	B	C
5462 *	Mask for 5421 and 5425	134	74	6,5

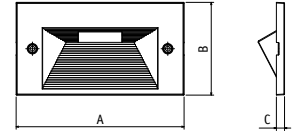
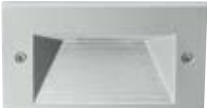

NEW

CODE NO.	Description	A	B	C
5463 *	Mask for 5430	134	74	6,5

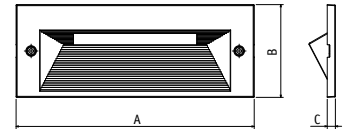

NEW

CODE NO.	Description	A	B	C
5464 *	Mask for 5435	190	74	6,5

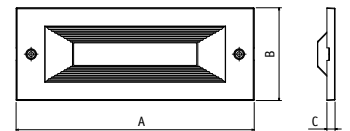

NEW

CODE NO.	Description	A	B	C
5465 *	Mask for 5440	190	74	6,5

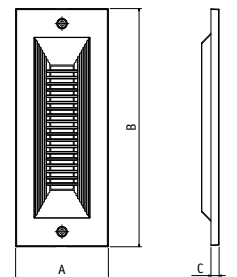

NEW

CODE NO.	Description	A	B	C
5466 *	Mask for 5440	74	190	6,5

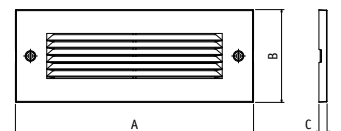

NEW

CODE NO.	Description	A	B	C
5467 *	Mask for 5440	190	74	6,5



- Covering masks in stainless steel 316 L
- Snap fastener + security screws
- Brushed and satin matt surface

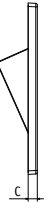
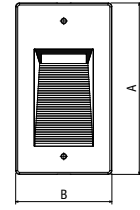

Colours **IN**

NEW

CODE NO.	Description	A	B	C
5472 *	Mask for 5421 and 5425	137	77	7,5

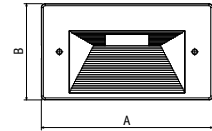

NEW

CODE NO.	Description	A	B	C
5473 *	Mask for 5430	137	77	7,5

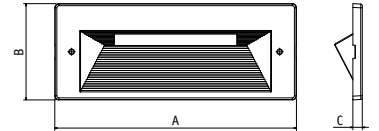

NEW

CODE NO.	Description	A	B	C
5474 *	Mask for 5435	193	77	7,5

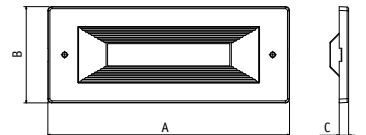

NEW

CODE NO.	Description	A	B	C
5475 *	Mask for 5440	193	77	7,5

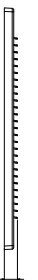
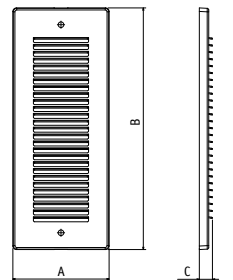

NEW

CODE NO.	Description	A	B	C
5476 *	Mask for 5440	77	193	10,5

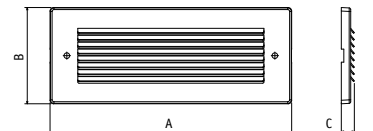

NEW

CODE NO.	Description	A	B	C
5477 *	Mask for 5440	193	77	10,5



- Backbox in technopolimer
- Cover included

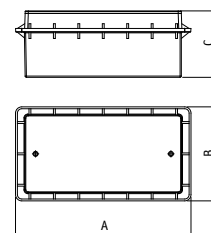

NEW

CODE NO.	Description	A	B	C
5481	Backbox for bodies 5421-5425-5430	140	75	53



- Backbox in technopolimer
- Cover included

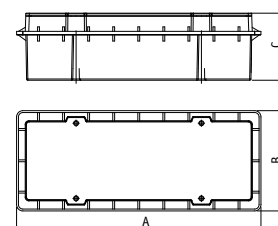

NEW

CODE NO.	Description	A	B	C
5482	Backbox for bodies 5435-5440	195	80	53



- Lighting filters

Colours **AR** **VE** **BL** **RO**

NEW

CODE NO.	Description
5485 *	Dichroic filter for bodies 5425-5430
5486 *	Dichroic filter for bodies 5435-5440



Quantum aluminium post



- Structure, base and top in aluminium
- Made to receive body 5421 or 5425 and mask 5462
- Option to insert the body 5440 and the mask 5465 or 5466
- Connection box inside
- Pre-phosphochromed UV resistant painting
- This series conforms to EN 60 439-1 C €

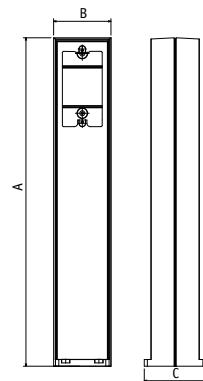

Colours GR GM

NEW

CODE NO.	Description	A	B	C
5491 *	Post for Quantum fitting	495	86,5	93

Post only. Quantum fitting supplied separately.

Quantum stainless steel post



- Structure in stainless steel 316 L
- Made to receive body 5421 or 5425 and mask 5472
- Option to insert the body 5440 and the mask 5475 or 5476
- Connection box inside
- Brushed and satin matt surface
- This series conforms to EN 60 439-1 C €

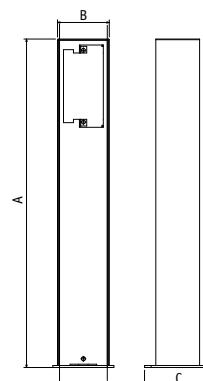

Colours IN

NEW

CODE NO.	Description	A	B	C
5492 *	Stainless steel post for Quantum fitting	495	66	100

Post only. Quantum fitting supplied separately.

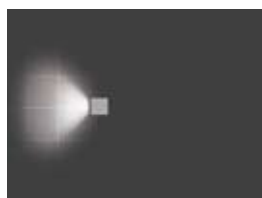

Quantum post. One light.

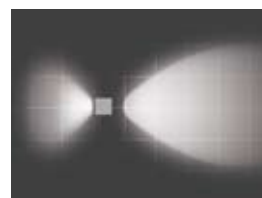
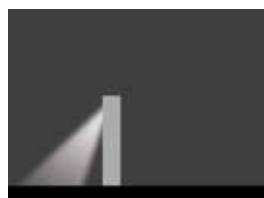

Quantum post. Two lights.



Quantum plate with anchoring set



- Stainless steel plate with ground anchoring set
- To be installed with codes 5491 - 5492

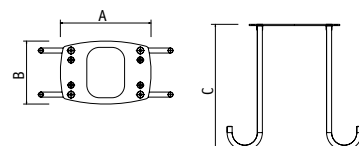

CODE NO.	Description	A	B	C
5496	Plate with anchoring set	92	77	200

goccia
ILLUMINAZIONE

Goccia Illuminazione S.r.l.

Via E. Fermi, 59/65 - 25020 Poncarale (BS) Italy
Tel. +39.030.26.40.761 r.a. - Fax +39.030.26.40.271
www.goccia.it - info@goccia.it